

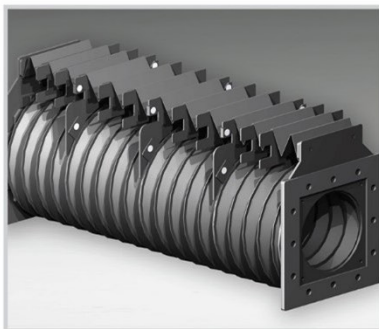

**Richardson
Electronics**

POWER & MICROWAVE
TECHNOLOGIES

Laser Parts & Consumables Suitable for TRUMPF® Lasers



rellaser.com | laser@rell.com

All product and company names are trademarks™ or registered® trademarks of their respective holders. Use of the trademarks is solely for identification purposes, and does not imply any affiliation with or endorsement by the trademark holders.

Why Richardson Electronics?



Global Headquarters in LaFox, Illinois, U.S.A.













Richardson Electronics is a global distributor of RF tubes (power grid tubes) and consumables used in industrial lasers. With over 75 years of experience and sales offices and stocking locations around the world, we provide the highest standard of quality and service. Our commitment to providing the best products to meet our customers' needs is second to none.

We stock critical components for laser systems and provide expert assistance in selecting replacement products and alternatives. Richardson Electronics is a world leading supplier of laser consumables. We have an extensive global supply network which helps us maintain a large inventory of replacement parts for laser machines from the industry's leading manufacturers.

All of Richardson Electronics' laser consumables are manufactured to the highest standards of quality and performance that meet, or exceed the OEM's original specifications. Our replacement parts for TRUMPF®, Bystronic® and other major manufacturers' lasers, deliver the same level of performance as OEM parts, but are a far more cost effective alternative.

Contact Richardson Electronics today for more information, or request a quote for your laser replacement parts.

Index

	Page
 Air Filters	47
 Bellows	23
 Ceramics	12
 Driver Stages	19
 Dust Collection Filters	44
 Frequency Converters and Power Supplies	20
 Hyco Pumps	21
 Nozzles	4
 Optics	14
 Tubes & Accessories	17
 Water Filters & Filter Material	50
 Water Treatment Kits	49



Nozzles & Accessories



Richardson Electronics offers an extensive selection of nozzle sizes and configurations to cover the full range of laser capabilities. Our nozzles and ceramics offer OEM-quality at competitive prices. With more than 200 different styles and sizes in stock, we can supply the nozzles you need tomorrow and we are always adding new consumables, so please check with us if you do not find the parts you need.



Nozzles

EAA



Trumpf No.	Order No.	Description (Sold in packages of 10)
1324858	RNT060/08	Nozzle EAA ø 0.8 mm
1324860	RNT061/10	Nozzle EAA ø 1.0 mm
1324861	RNT062/12	Nozzle EAA ø 1.2 mm
1324863	RNT063/14	Nozzle EAA ø 1.4 mm
1324864	RNT064/17	Nozzle EAA ø 1.7 mm
1324865	RNT065/20	Nozzle EAA ø 2.0 mm
1324866	RNT066/23	Nozzle EAA ø 2.3 mm
1324867	RNT067/27	Nozzle EAA ø 2.7 mm

EAU



Trumpf No.	Order No.	Description (Sold in packages of 10)
2059462	RNT096/25	Nozzle EAU ø 2.5 mm
2060001	RNT097/30	Nozzle EAU ø 3.0 mm
2060004	RNT098/40	Nozzle EAU ø 4.0 mm
2060025	RNT099/60	Nozzle EAU ø 6.0 mm
2253595	RNT041/100	Nozzle EAU ø 10.0 mm

EAB



Trumpf No.	Order No.	Description (Sold in packages of 10)
1373324	RNT070/08	Nozzle EAB ø 0.8 mm
1373325	RNT071/10	Nozzle EAB ø 1.0 mm
1373326	RNT072/12	Nozzle EAB ø 1.2 mm
1373327	RNT073/14	Nozzle EAB ø 1.4 mm
1373328	RNT074/17	Nozzle EAB ø 1.7 mm
1373329	RNT075/20	Nozzle EAB ø 2.0 mm
1373330	RNT076/23	Nozzle EAB ø 2.3 mm
1373331	RNT077/27	Nozzle EAB ø 2.7 mm



ECE



Standard Copper Nozzles (Sold in packages of 10)		
Trumpf No.	Order No.	Description
0124561, 0237499	RNT150/08	Nozzle ECE ø 0.8 mm
0124562	RNT151/10	Nozzle ECE ø 1.0 mm
0966809	RNT148/12	Nozzle ECE ø 1.2 mm
0237497	RNT152/14	Nozzle ECE ø 1.4 mm With Step
0237497-S	RNT159/14	Nozzle ECE ø 1.4 mm With Straight Taper
0237500	RNT153/15	Nozzle ECE ø 1.5 mm
0237501	RNT154/17	Nozzle ECE ø 1.7 mm
1253211, 0237502 & 0237503	RNT155/20	Nozzle ECE ø 2.0 mm
0126933	RNT158/23	Nozzle ECE ø 2.3 mm
	RNT156/25	Nozzle ECE ø 2.5 mm
0942742	RNT149/27	Nozzle ECE ø 2.7 mm
0237504	RNT157/30	Nozzle ECE ø 3.0 mm



Hard Chromium Plated Nozzles (Sold in packages of 10)		
Trumpf No.	Order No.	Description
0352280	RNT150/08C	Nozzle ECE ø 0.8 mm Hard Chromium Plated
0352281	RNT151/10C	Nozzle ECE ø 1.0 mm Hard Chromium Plated
0352282	RNT148/12C	Nozzle ECE ø 1.2 mm Hard Chromium Plated
0352283	RNT152/14C	Nozzle ECE ø 1.4 mm with Step Hard Chromium Plated
0352283-S	RNT159/14C	Nozzle ECE ø 1.4 mm with Straight Taper Hard Chromium Plated
0352284	RNT154/17C	Nozzle ECE ø 1.7 mm Hard Chromium Plated
1253212	RNT155/20C	Nozzle ECE ø 2.0 mm Hard Chromium Plated
0352285	RNT158/23C	Nozzle ECE ø 2.3 mm Hard Chromium Plated
0352286	RNT149/27C	Nozzle ECE ø 2.7 mm Hard Chromium Plated



Nozzles

BrightLine Nozzles



Trumpf No.	Order No.	Description (Sold Individually)
1579549	RNT120/25	Nozzle EAK ø 2.5mm
1579556	RNT121/30	Nozzle EAK ø 3.0mm
1664569	RNT081/17	Nozzle EAN ø 1.7mm
1664602	RNT082/20	Nozzle EAN ø 2.0mm
1664625	RNT083/25	Nozzle EAN ø 2.5mm
1835747	RNT084/40	Nozzle EAK ø 4.0mm



Trumpf No.	Order No.	Description (Sold Individually)
1633046	RNT085/53	Nozzle EAC ø 5.3mm



Trumpf No.	Order No.	Description (Sold Individually)
1809091	RNT086/60	Nozzle EAQ ø 6.0mm
1809421	RNT087/75	Nozzle EAQ ø 7.5mm
1886199	RNT088/95	Nozzle EAQ ø 9.5mm

CoolLine Nozzles



Trumpf No.	Order No.	Description (Sold Individually)
1774018	RNT089/14	Nozzle EFL ø 1.4mm
1774020	RNT090/20	Nozzle EFL ø 2.0mm
1774092	RNT091/23	Nozzle EFL ø 2.3mm



Trumpf No.	Order No.	Description (Sold Individually)
1879940	RNT093/14	Nozzle EGL ø 1.4mm
1879951	RNT092/17	Nozzle EGL ø 1.7mm
1879952	RNT094/20	Nozzle EGL ø 2.0mm
1879953	RNT095/23	Nozzle EGL ø 2.3mm



Nozzles

EBD



Standard Copper Nozzles (Sold in packages of 10) <i>(Chromium plated nozzles available upon request)</i>		
Trumpf No.	Order No.	Description
1354230	RNT008/08	Nozzle EBD ø 0.8 mm
0212334	RNT010/10	Nozzle EBD ø 1.0 mm
1479581	RNT037/12	Nozzle EBD ø 1.2 mm
0216199	RNT011/14	Nozzle EBD ø 1.4 mm
0225213	RNT012/17	Nozzle EBD ø 1.7 mm
1487009	RNT038/20	Nozzle EBD ø 2.0 mm
1487009	RNT034/20	Nozzle EBD, High Pressure ø 2.0 mm
0126156	RNT028/23	Nozzle EBD ø 2.3 mm
2077094	RNT039/27	Nozzle EBD ø 2.7 mm

EBG & EBF



Slim Copper Nozzles (Sold in packages of 10) <i>(Chromium plated nozzles available upon request)</i>		
Trumpf No.	Order No.	Description
0913799	RNT020/08	Nozzle EBG ø 0.8 mm
0913800	RNT021/10	Nozzle EBG ø 1.0 mm
1487034	RNT035/12	Nozzle EBG ø 1.2 mm
0913801	RNT022/14	Nozzle EBG ø 1.4 mm
0937988	RNT023/17	Nozzle EBF ø 1.7 mm
1487036	RNT036/20	Nozzle EBF ø 2.0 mm
937989, 0937989	RNT024/23	Nozzle EBF ø 2.3 mm
1546809	RNT031/27	Nozzle EBF ø 2.7 mm



Nozzles



Long Copper Nozzles (Sold in packages of 10) <i>(Chromium plated nozzles available upon request)</i>		
Trumpf No.	Order No.	Description
1277773	RNT130/08	Nozzle ø 0.8 mm
1277771	RNT131/10	Nozzle ø 1.0 mm
1277774	RNT132/12	Nozzle ø 1.2 mm
1277776	RNT133/14	Nozzle ø 1.4 mm
1277779	RNT134/17	Nozzle ø 1.7 mm
1277780	RNT135/20	Nozzle ø 2.0 mm
1277781	RNT136/23	Nozzle ø 2.3 mm
1277782	RNT137/27	Nozzle ø 2.7 mm



Standard Copper Nozzles (Sold in packages of 10) <i>(Chromium plated nozzles available upon request)</i>		
Trumpf No.	Order No.	Description
0226939	RNT013/10	Nozzle ø 1.0 mm
0226940	RNT014/14	Nozzle ø 1.4 mm
0227144	RNT015/17	Nozzle ø 1.7 mm



Standard Copper Nozzles (Sold in packages of 10) <i>(Chromium plated nozzles available upon request)</i>		
Trumpf No.	Order No.	Description
	RNT016/10	Nozzle ø 1.0 mm
	RNT017/14	Nozzle ø 1.4 mm
	RNT018/17	Nozzle ø 1.7 mm
	RNT030/23	Nozzle ø 2.3 mm



Standard Rough Edged Copper Nozzles (Sold in packages of 10) <i>(Chromium plated nozzles available upon request)</i>		
Trumpf No.	Order No.	Description
0135320	RNT225/10	Nozzle ø 1.0 mm Rough Edged
	RNT226/12	Nozzle ø 1.2 mm Rough Edged
0135318	RNT220/14	Nozzle ø 1.4 mm Rough Edged
0126157	RNT221/17	Nozzle ø 1.7 mm Rough Edged



Nozzles



Standard Copper Nozzles (Sold in packages of 10) (Chromium plated nozzles available upon request)		
Trumpf No.	Order No.	Description
0958206	RNT006/025	"Teach" Nozzle \varnothing 0.25 mm
0913799	RNT020/08	Nozzle \varnothing 0.8 mm
0913800	RNT021/10	Nozzle \varnothing 1.0 mm
0913801	RNT022/14	Nozzle \varnothing 1.4 mm
0937988	RNT023/17	Nozzle \varnothing 1.7 mm
0937989	RNT024/23	Nozzle \varnothing 2.3 mm

Specialty Nozzles

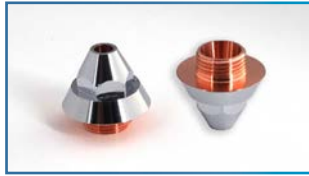

Trumpf No.	Order No.	Description
932530	RNT200/45C	Nozzle 4.5 mm Hard Chromium Plated (sold individually)



Trumpf No.	Order No.	Description
1384753	RNT301/20	Nozzle Crossjet 2.0 mm (sold in packages of 10)



Trumpf No.	Order No.	Description
2491660	RNT870/100	Nozzle CAU 10.0 mm - with reflection-free finish (sold in packages of 10)

ECP Nozzles



ECP Copper Nozzles (Sold in packages of 10)		
Trumpf No.	Order No.	Description
1851641	RNT350/08	Nozzle \varnothing 0.8 mm
1851587	RNT351/10	Nozzle \varnothing 1.0 mm
1851588	RNT352/12	Nozzle \varnothing 1.2 mm
1851618	RNT353/14	Nozzle \varnothing 1.4 mm
1851619	RNT354/17	Nozzle \varnothing 1.7 mm
1851620	RNT355/20	Nozzle \varnothing 2.0 mm
1851651	RNT356/23	Nozzle \varnothing 2.3 mm
1851652	RNT357/27	Nozzle \varnothing 2.7 mm



Nozzles

Precitec® Nozzles



Precitec No.	Order No.	Description (Sold in packages of 10)
P0578-0412-00012	RNP021/12	Nozzle ø 1,2 mm
P0578-0413-00015	RNP022/15	Nozzle ø 1,5 mm
P0578-0414-00018	RNP023/18	Nozzle ø 1,8 mm
P0578-0415-00020	RNP024/20	Nozzle ø 2,0 mm
P0578-0417-00025	RNP025/25	Nozzle ø 2,5 mm



Precitec No.	Order No.	Description (Sold in packages of 10)
P0591-569-00008	RNP101/08	Nozzle ø ,8 mm
P0591-561-00010	RNP102/10	Nozzle ø 1,0 mm
P0591-562-00012	RNP103/12	Nozzle ø 1,2 mm
P0591-563-00015	RNP104/15	Nozzle ø 1,5 mm
P0591-564-00018	RNP105/18	Nozzle ø 1,8 mm
P0591-565-00020	RNP106/20	Nozzle ø 2,0 mm
P0591-566-00025	RNP107/25	Nozzle ø 2,5 mm
P0591-568-00030	RNP108/30	Nozzle ø 3,0 mm



Precitec No.	Order No.	Description (Sold in packages of 10)
P0591-571-00010	RNP130/10	Nozzle ø 1,0 mm
P0591-572-00012	RNP131/12	Nozzle ø 1,2 mm
P0591-573-00015	RNP132/15	Nozzle ø 1,5 mm
P0591-574-00018	RNP133/18	Nozzle ø 1,8 mm
P0591-575-00020	RNP134/20	Nozzle ø 2,0 mm
	RNP135/22	Nozzle ø 2,2 mm
P0591-576-00025	RNP136/25	Nozzle ø 2,5 mm
	RNP137/27	Nozzle ø 2,7 mm
P0591-577-00030	RNP138/30	Nozzle ø 3,0 mm

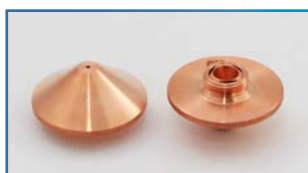

Precitec No.	Order No.	Description (Sold in packages of 10)
P0591-002-00010	RNP300/10D	Double Nozzle ø 1,0 mm
P0591-002-00012	RNP301/12D	Double Nozzle ø 1,2 mm
P0591-002-00015	RNP302/15D	Double Nozzle ø 1,5 mm
P0591-002-00018	RNP303/18D	Double Nozzle ø 1,8 mm
P0591-002-00020	RNP304/20D	Double Nozzle ø 2,0 mm
P0591-002-00023	RNP305/23D	Double Nozzle ø 2,3 mm
P0591-002-00025	RNP306/25D	Double Nozzle ø 2,5 mm
P0591-002-00030	RNP307/30D	Double Nozzle ø 3,0 mm
P0591-002-00035	RNP308/35D	Double Nozzle ø 3,5 mm

Check rellaser.com or contact us for other parts for Precitec.

Richardson Electronics, Ltd. | rellaser.com | laser@rell.com | Find our Local Sales Offices at rell.com/contact-us

All product and company names are trademarks™ or registered® trademarks of their respective holders. Use of the trademarks is solely for identification purposes, and does not imply any affiliation with or endorsement by the trademark holders.



Ceramic Nozzle Holders



Trumpf No.	Order No.	Description (Sold individually)
0260432	RHT109/H	Ceramic Nozzle Holder DIAS III M8



Trumpf No.	Order No.	Description
0936678, 2509767	RHT110/H	Ceramic Nozzle Holder M6



Trumpf No.	Order No.	Description
0258809, 0243839 & 0247894	RHT111/H	Ceramic Nozzle Holder M8



Trumpf No.	Order No.	Description (Sold individually)
1349171, 1591594, 1755673	RHT112/H	Ceramic Nozzle Holder M12



Trumpf No.	Order No.	Description (Sold individually)
1906032	RHT116/H	Ceramic Nozzle Holder M12



Precitec No.	Order No.	Description (Sold individually)
P0571-1051-00001	RHP100/H	Nozzle Holder, Conical KT B2



OEM No.	Order No.	Description (Sold individually)
P0494-752-00001, 092405	RHP101/H	Nozzle Holder M6



Accessories



Trumpf No.	Order No.	Description
0225286	RTT160/TC	Teflon Cover, White (Lasermatic)



Trumpf No.	Order No.	Description
0254496	RTT161/TC	Teflon Cover, White



Trumpf No.	Order No.	Description
0256153	RTT162/TC	Teflon Cover DIAS III, White



Trumpf No.	Order No.	Description
0955826	RTT162/TCB	Teflon Cover DIAS III, Black

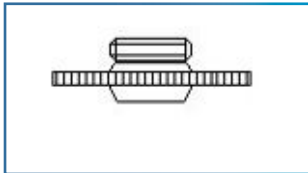

Trumpf No.	Order No.	Description
-	RMT139/NOZZLE-ADAPT	Adapter for Precitec KTB2 Heads to M8 thread, used for ECE nozzles.



Trumpf No.	Order No.	Description
0234485	RMT163/BAB	Break Away Bar



Trumpf No.	Order No.	Description
913965, 0936678	RMT007/NUT	Locking Nut



Optics & Cleaning Supplies

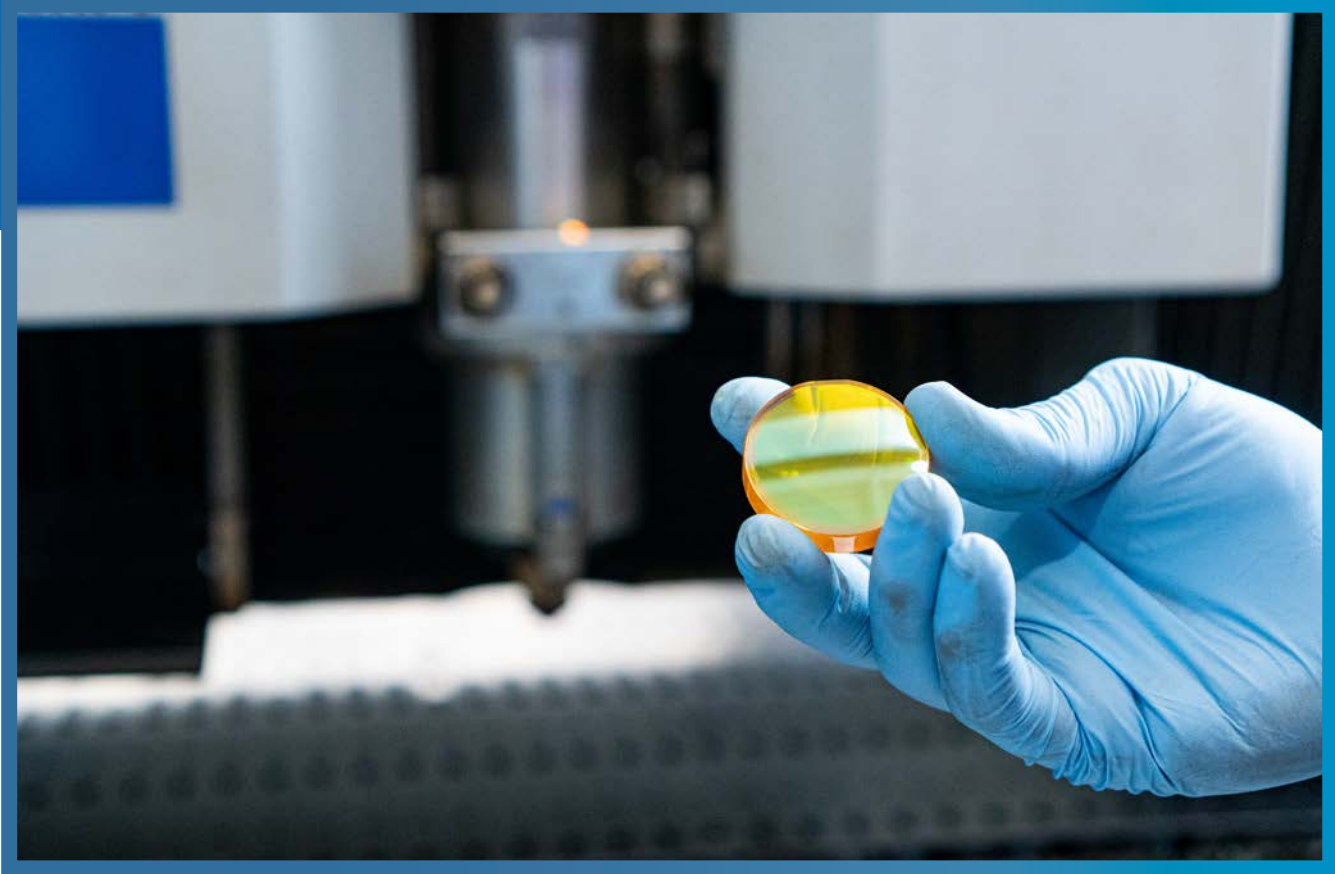

Richardson Electronics lenses and mirrors are manufactured using the highest quality materials and tightest process controls available in the industry. Every optic undergoes thorough quality controls to ensure you will get the best performance in your laser. Our standard lenses meet or exceed OEM specifications. Our low absorption lenses are the best choice for laser powers of 4 KW and up. Our optics can help you reduce the total cost of operation of your laser.



Lenses and Protective Lens Covers



Lenses for CO ₂ Lasers		
Trumpf No.	Order No.	Description
088114	RLT100/50S	5" F/L, 1.5" Dia., 0.291 ET, AR ≤ 0.20%
088114	RLT200/50LA	5" F/L, 1.5" Dia., 0.291 ET, AR ≤ 0.15% (Low Absorption)
097517	RLT101/75S	7.5" F/L, 1.5" Dia., 0.291 ET, AR ≤ 0.20%
097517	RLT201/75LA	7.5" F/L, 1.5" Dia., 0.291 ET, AR ≤ 0.15% (Low Absorption)
0141972	RLT103/90S	9" F/L, 1.5" Dia., 0.291 ET, AR ≤ 0.20%
0346104	RLT102/375S	3.75" F/L, 1.5" Dia., 0.291 ET, AR ≤ 0.20%
0350163	RLT104/100S	10" F/L, 1.5" Dia., 0.291 ET, AR ≤ 0.20%
0380117	RLT106/50S	130mm F/L, D40, 7.5mm ET, Cut Lens (Without RFID Chip)
1330414	RLT109/45S	115mm F/L, D50, 8.9mm ET, Cut Lens (Without RFID Chip)
1330448	RLT108/70S	175mm F/L, D50, 8.9mm ET, Cut Lens (Without RFID Chip)
1383925	RLT125/60S	155mm F/L, D40, 7.5mm ET, AR/AR
380115	RLT105/100S	250mm F/L, 40mm Dia, 7.5mm ET cut lens (Without RFID chip)
1383926	RLT126/90S	240mm F/L, D40, 7.5mm ET, AR/AR
1330443	RLT107/100S	250mm F/L, 50mm Dia, 8.9mm ET, Cut Lens (Without RFID chip)
1525872	RLT112/70S	170mm F/L, D50, 8.9mm ET, Cut Lens (Without RFID Chip)

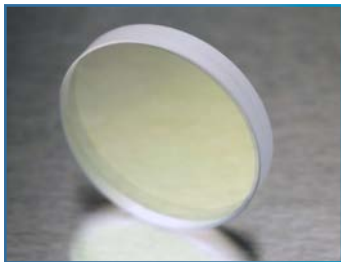

Protective Lens Covers and Lenses for Fiber Lasers		
Trumpf No.	Order No.	Description
1792250	RLT131/24D5T	24 Dia. x 5mm Thick, Fused Silica Protective Window
0766719	RLT128/30D5T	30 Dia. x 5mm Thick, Fused Silica Protective Window
0766719, 6930003298, 1000404	RLT130/30D5THP	30 Dia. x 5mm Thick, Fused Silica Protective Window for +8kW Fiber Lasers
1614767	RLT120/PLC-FIBR	34 Dia. x 5mm Thick, Fused Silica Window
1887343	RLT343/38D7T	38 Dia. x 7.0 mm Thick, Fused Silica Window
1603107	RLT135/40D8.1T150FL	40 Dia. x 8.1mm Thick, Fused Silica Lens
2627294, 1869799	RLT136/30D8.1T150FL	30 Dia. x 8.1mm Thick, Fused Silica Lens
1651502	RLT137/40D5T	40 Dia. x 5mm Thick, Fused Silica Protective Window
2625026	RLT124/40D7T	40 Dia. x 7mm Thick, Fused Silica Protective Window
0759720, '0798142	RLT122/55D1.5T	55 Dia. x 1.5mm Thick, Fused Silica Protective Window
1584792	RLT132/55D1.5TBB	55 Dia. x 1.5mm Thick, Fused Silica Broad Band Protective Window 900-1090nm
1615516	RLT516/55D1.5TSW	55 Dia x 1.5mm Thick, Fused Silica Protective Window
1254813	RLT813/134D3T	134 Dia. x 3.0 mm Thick, Fused Silica Window

Richardson Electronics, Ltd. | rellaser.com | laser@rell.com | Find our Local Sales Offices at rell.com/contact-us

All product and company names are trademarks™ or registered® trademarks of their respective holders. Use of the trademarks is solely for identification purposes, and does not imply any affiliation with or endorsement by the trademark holders.



Mirrors & Optics Cleaning Supplies



Mirrors		
Trumpf No.	Order No.	Description
0129880	RRT103/90PS	Si 90 Phase Shift 68mm x 20mm
0129881	RRT102/0PS	Si 0 Phase Shift 68mm x 20mm
0365640	RRT114/90PS	Cu 90 Phase Shift 68mm x 20.32mm
0920689	RRT104/CUWC	Cu W/C Mirror 68mm x 34mm
0977219	RRT219/U	U Mirror set, includes seven MMR mirrors, one PLM mirror and mounting o-rings
1331867	RRT867/PLM	Polarize Lock Mirror, includes mounting o-rings
1492304	RRT304/MMR	MMR Mirror includes mounting o-rings



Optics Cleaning Supplies		
Trumpf No.	Order No.	Description
0240568, 0367432, 121095, 2243506	RLT568/TOPOL80	Topol Lens Cleaner (80ml Bottle)
1687226	RLT226/LRGPAPER	Large Lens Cleaning Paper - 50 Pack - Sheet size 4 x 7.75" (102 x 197mm)
086452, 13082010	EK1546027T	Lens Cleaning Paper - 50 Pack - Sheet size 2.75 x 4.75" (70 x 121mm)
	EK1463728T	Lens Cleaning Solution - 16 oz.
1222024	RLT024/LNSTICK	Knit Polyester Cleaning Swabs (100/pack)
	MIRR-POL/390050	Mirror Polishing Compound



Power Grid Tubes



Richardson Electronics is the number one supplier of replacement RF power tubes for TRUMPF® lasers. We supply Thales RF power tubes that are manufactured to the same high standards of quality as the original OEM tubes. Our aftermarket CO₂ laser RF power tubes represent a cost-effective alternative to lower your overall cost of ownership and maintenance for your TRUMPF® laser system.

CO₂ laser tubes from Richardson Electronics deliver the same level of performance and dependability as OEM tubes. Our replacement RF power tubes function exactly the same as TRUMPF® OEM tubes, but at lower prices.



Trumpf No.	Order No.	Description
0120730, 1290700, 1347276, 1582540, 1800928 1800961, 1800985, 1801047, 1803428, 1544681	RS3021CJ	for lasers up to 4kW



Trumpf No.	Order No.	Description
0932468, 1237260, 1237228, 1237398, 1296799, 1582457, 1800986, 1811787, 1812660, 1800987	RS2048CJC	for lasers 5kW and higher and TruCoax 3.2kW

Richardson Electronics, Ltd. | rellaser.com | laser@rell.com | Find our Local Sales Offices at rell.com/contact-us

All product and company names are trademarks™ or registered® trademarks of their respective holders. Use of the trademarks is solely for identification purposes, and does not imply any affiliation with or endorsement by the trademark holders.



Power Grid Tube Accessories

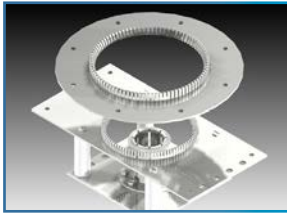

Trumpf No.	Order No.	Description
1201187, 1548071	ROEKG321G	Socket for End Stage tube type RS3021CJ



Trumpf No.	Order No.	Description
911332, 1548072	ROEKG248K	Socket for End Stage tube type RS2048CJC



Trumpf No.	Order No.	Description
1601003	AX2048CJ-KIT	Sacrificial Anode Water Connection Kit
This is an add-on item sold only in conjunction with our RS2048CJC tube		



Trumpf No.	Order No.	Description
087596	AX3021CJ-KIT	Sacrificial Anode Water Connection Kit
This is an add-on item sold only in conjunction with our RS3021CJ tube		



Trumpf No.	Order No.	Description
0925091, 1520715	TUBE-EXTRACTOR	End Stage tube extraction tube
Works on the RS2048CJC and RS3021CJ		



Driver Stages

Trumpf CO₂ lasers are highly complex machines, with thousands of parts and many major components. The failure of any one of them will stop your production, and some cost tens of thousands of dollars to replace.

As part of our program of providing engineered solutions, the engineers at Richardson Electronics have developed a complete rebuilding process for several of these major components, including driver stages, frequency converters, and power supplies. The rebuilding process is done through a series of more than 30 individual diagnostic and repair steps, calibration, and a real-world test cycle, ensuring that it will operate at original factory specifications. And we back our rebuild process with a 12-month warranty.

To minimize your down time, we keep the rebuilt units in stock. To maximize the value, we offer core credits for your old units. If you have any of these old components lying around your shop, contact us to learn how you can turn it into a working spare or a into the laser parts and consumables you need.



Trumpf No.	Power Output	Frequency	Order No.
0087597, 0102687	600W	13.56 Mhz	Discontinued - Alternative type = RDS1KW13-R
0954356, 0990818, 1286829, 1288251, 1544591, 1544595	650W	13.56 Mhz	RDS650W13-R
1313254, 1392849, 1726682, 1760569, 1829407, 2642769	650W Class "E"	13.56 Mhz	RDS650W13E-R
0131606, 0149214, 1286827, 1288252, 1597793, 1633973	1000W	13.56 Mhz	RDS1KW13-R
1258223, 1368226, 1726681, 1746606	1000W Class "E"	13.56 Mhz	RDS1KW13E-R
0102130, 0102654	1200W	13.56 Mhz	Discontinued - Alternative type = RDS1KW13-R
0139823, 0342740, 1286828, 1288256, 1597794, 1633972	2000W	13.56 Mhz	RDS2KW13-R
1303885, 1383930, 1726678, 1746609, 1829431, 2642765, 2792090	2000W Class "E"	13.56 Mhz	RDS2KW13E-R
0920105, 0921405, 1293759, 1323934	1000W	27.12 Mhz	RDS1KW27-R
0180759, 1391564, 1726679,	1200W Class "E"	27.12 Mhz	RDS1.2KW27E-R



Frequency Converters & Power Supplies



Trumpf No.	Order No.	Description
0359329, 0368126, 1645226	IMC15-R	MECOS IMC15 Frequency Converter, Rebuilt



Trumpf No.	Order No.	Description
148428	VF1424L-R	LUST Frequency Inverter, Rebuilt



Hyco Vacuum Pumps

We are offering replacement Hyco vacuum pumps for Trumpf® CO₂ laser systems. These are direct drop in replacements.

We offer both the original hardwire version and the newer plug version; the only aftermarket options that provide the exact OEM specifications.



Trumpf No.	Order No.	Description
0149023, 0352561, 0941996, 0946052	RPT203/PUMP	Hyco Vacuum Pump (Hard Wired)



Trumpf No.	Order No.	Description
0367905, 0385475, 1363752, 1363753, 2237816, 2237817, 2710409	RPT752/PUMP	Hyco Vacuum Pump (With 4 Pole Receptacle Connector)

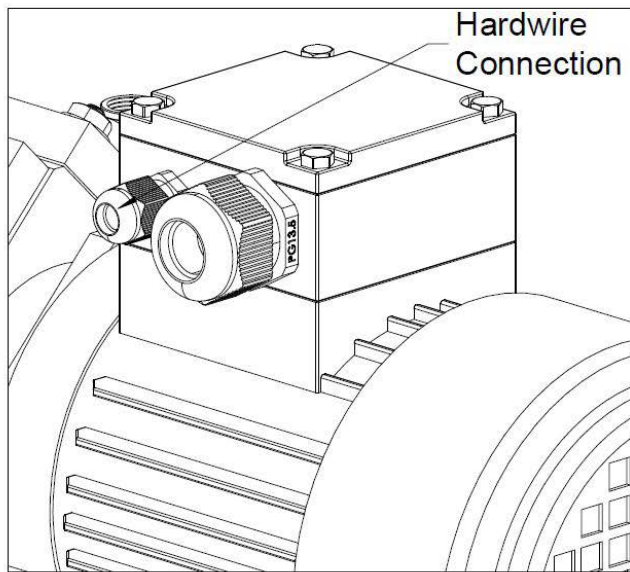

RPT203/PUMP

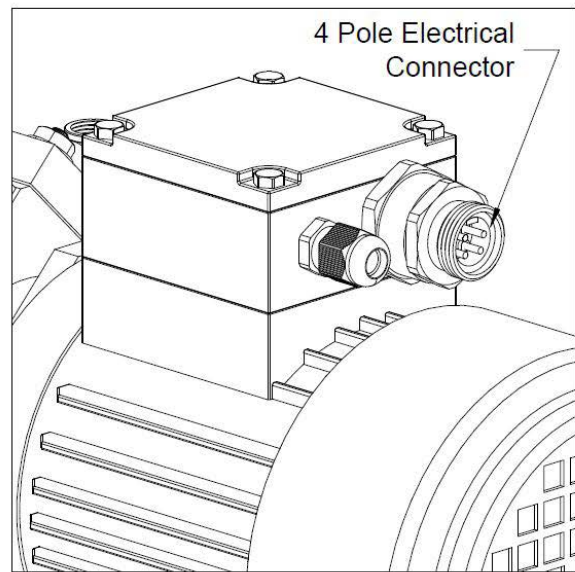

RPT752/PUMP



Fan and Battery Assemblies



Trumpf No.	Order No.	Description
0146881	RST881/FAN/BATT	Used in Siemens NCU 840D (control module)



Trumpf No.	Order No.	Description
0385837	RST837/FAN/BATT	Used in Siemens NCU 7X0 and D445-1 (control module)

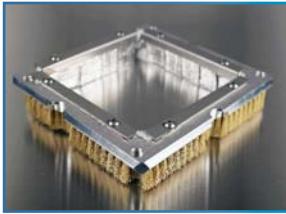

Trumpf No.	Order No.	Description
353202, 0353202, 0900593	RUT202/BRUSH	600L & 6000L Punch/Laser Protection Brush



Bellows

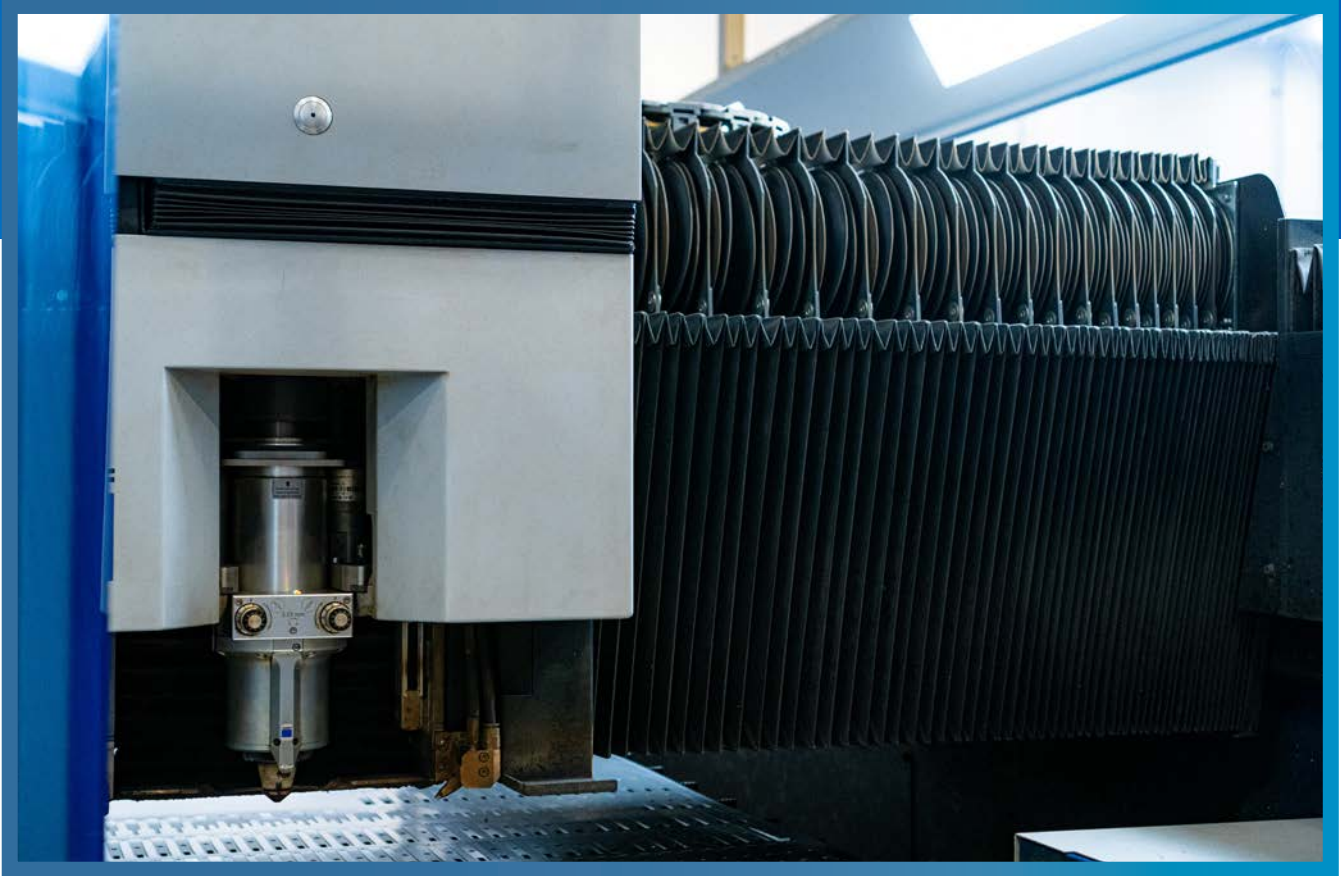

Richardson Electronics is a worldwide distributor of laser bellows for machines from most major manufacturers. We offer bellows made specifically for your laser machine. Designed and manufactured in Europe, our laser bellows are made with heat resistant, flame retardant materials and are able to withstand high operating temperatures while providing years of service.

In addition, tight fitting laser bellows keep unwanted particles out of the laser beam and protect machine rails, racks and bearings, to keep your laser machine running smoothly. Visit rellaser.com for detailed technical drawings of our bellows.

Did you know that delaying the replacement of your worn, hole filled, beam & beam path bellows can increase your monthly usage (and cost) of the nitrogen used in the beam purge? It pays to replace your worn bellows!

For L3030 & TruLaser 3030

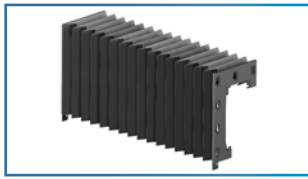

Trumpf No.	Order No.	Description
0921742	RBT100/30RX	X Axis Rail Bellow (each)

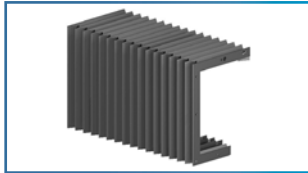

Trumpf No.	Order No.	Description
0141394	RBT101/30RX	Y Axis Rail Bellow (each)



Trumpf No.	Order No.	Description
0910354, 124395, 0124395, 2342414	RBT102/30BPZ	Z Axis Beam Path Bellow



Trumpf No.	Order No.	Description
0939015, 1667803, 2356581, 1306468	RBT103L/30BPX *#	X Axis Beam Path Bellow (Rear)



Trumpf No.	Order No.	Description
'0939016, 1667805, 2356591, 1306466	RBT104L/30BPY #	Y Axis Beam Bellow (Left)



Trumpf No.	Order No.	Description
0124393, 0908032, 0920715, 1667790, 2356539, 1306469	RBT105L/30BX #	X Axis Beam Bellow (Front)



Trumpf No.	Order No.	Description
0124394, 0908033, 0920716, 1667801, 1306467, 2356537	RBT106L/30BY #	Y Axis Beam Bellow (Right)

*If your laser has the long beam clipper (typically found on machines built prior to 2000) it will need to be changed to the newer shorter version before using this replacement bellow.

These bellows are used in older/ Classic model 3030 machines (not 3030 L20). These machines had originally square beam bellows and have either been retrofitted to disk bellows or have been built with disk bellows in newer models. Our square bellows have the same attachment to the frame as both the square and disk bellows and being made of polyurethane with rounded corners, share the benefits of the disk bellows.

TRUMPF® machine models are for reference only, please check your machine manual for the actual part number needed. Our technical drawings can be found at www.rellaser.com. Please contact us if you do not find the item you need.



For L3530

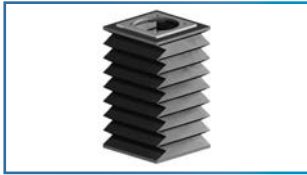

Trumpf No.	Order No.	Description
0910354, 124395, 0124395, 2342414	RBT102/30BPZ	Z Axis Beam Path Bellows



Trumpf No.	Order No.	Description
1667803	RBT103L/30BPX	X Axis Beam Path Bellows (Rear)



Trumpf No.	Order No.	Description
1667790	RBT105L/30BX	X Axis Beam Bellows (Front)



Trumpf No.	Order No.	Description
0362270	RBT250/353BPY	Y Axis Beam Path Bellows (Left)



Trumpf No.	Order No.	Description
0362271	RBT251/353BY	Y Axis Beam Bellows (Right)



Trumpf No.	Order No.	Description
0362272	RBT252/353BPX2	X Axis Beam Bellows (Front)



Trumpf No.	Order No.	Description
0362273	RBT253/353BX2	X Axis Beam Path Bellows (Rear)

TRUMPF® machine models are for reference only, please check your machine manual for the actual part number needed. Our technical drawings can be found at www.rellaser.com. Please contact us if you do not find the item you need.



For L3030 (L20) & L3040 (L32)



Trumpf No.	Order No.	Description
1443233	Order separately	This is a kit that contains 1 each 1496435 (RBT121/30L20RBT) & 1496436 (RBT120/30L20RBPY)

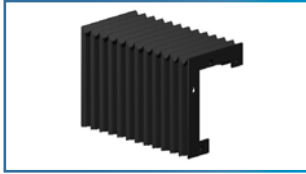

Trumpf No.	Order No.	Description
1458866, 1865268	RBT116/30RRX	X Axis Rail Bellow (Right)

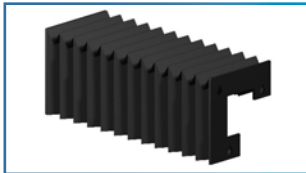

Trumpf No.	Order No.	Description
1458867, 1865269	RBT117/30LRX	X Axis Rail Bellow (Left)



Trumpf No.	Order No.	Description
1458861, 1854032	RBT118/30L20BPX	X Axis Beam Path Bellow (Round) (Rear)

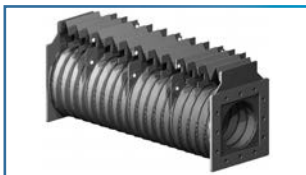

Trumpf No.	Order No.	Description
1458860	RBT119/30L20BX	X Axis Beam Bellow (Round) (Front)



Trumpf No.	Order No.	Description
1496436	RBT120/30L20RBPY	Y Beam Path/Rail Combo Bellow (Round) (Left)

TRUMPF® machine models are for reference only, please check your machine manual for the actual part number needed. Our technical drawings can be found at www.rellaser.com. Please contact us if you do not find the item you need.



For L3030 (L20) & L3040 (L32)



Trumpf No.	Order No.	Description
1496435	RBT121/30L20RBY	Y Beam/Rail Combo Bellow (Round) (Right)



Trumpf No.	Order No.	Description
1561554	RBT122/30L20CZ	Z Axis Chest Bellow



Trumpf No.	Order No.	Description
1570975, 1865321	RBT340/4030L32RRX	X Axis Rail Bellow (Right)

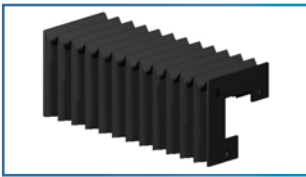

Trumpf No.	Order No.	Description
1570976, 2012183	RBT341/4030L32LRX	X Axis Rail Bellow (Left)



Trumpf No.	Order No.	Description
1559392	RBT342/4030L32RBY	Y Beam/Rail Combo Bellow (Round) (Right)



Trumpf No.	Order No.	Description
1718971, 1867322	RBT345/5040RXL	X Axis Rail Bellow



Trumpf No.	Order No.	Description
1802766	RBT766/30L20RBY	Y-Axis Beam/Rail Combo Bellow (Round) (Right)

TRUMPF® machine models are for reference only, please check your machine manual for the actual part number needed. Our technical drawings can be found at www.rellaser.com. Please contact us if you do not find the item you need.



For L3050 (Prior to Mid-2005)

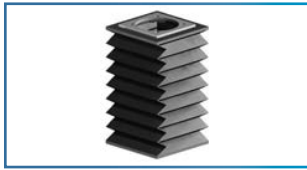

Trumpf No.	Order No.	Description
0910354, 124395, 0124395, 2342414	RBT102/30BPZ	Z Axis Beam Path Bellow



Trumpf No.	Order No.	Description
0981757, 1302020, 1596087	RBT131/50RX	X Axis Rail Bellow (Left/Front & Middle)



Trumpf No.	Order No.	Description
0986703, 1226192	RBT132/50RBY	Y Axis Beam/Rail Combo Bellow (Left)

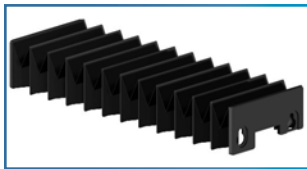

Trumpf No.	Order No.	Description
0981753, 1302386	RBT133/50RU	U Axis Rail Bellow (Front & Rear)



Trumpf No.	Order No.	Description
0981756, 1302018, 1596088, 1873857	RBT135/50RX	X Axis Rail Bellow (Left/Rear)

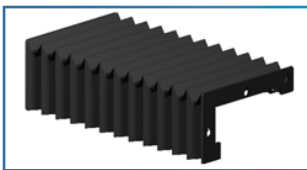

Trumpf No.	Order No.	Description
0981710	RBT136/50RX	X Axis Rail Bellow (Right/Front & Rear)

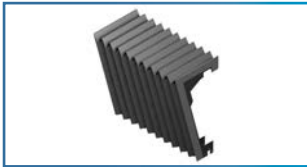

Trumpf No.	Order No.	Description
0993338, 1226193	RBT137/50RY	Y Axis Rail Bellow (Right)

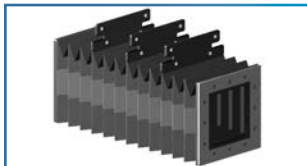

Trumpf No.	Order No.	Description
0978079	RBT138/50UXBP	U & X Axis Beam Path Bellow

TRUMPF® machine models are for reference only, please check your machine manual for the actual part number needed. Our technical drawings can be found at www.rellaser.com. Please contact us if you do not find the item you need.



Bellows

For L3050 (Mid-2005 & After) & TruLaser 5030

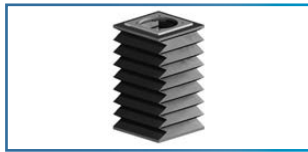

Trumpf No.	Order No.	Description
0910354, 124395, 0124395, 2342414	RBT102/30BPZ	Z Axis Beam Path Bellow



Trumpf No.	Order No.	Description
1873856	RBT129/50RX	X-Axis Rail Bellow

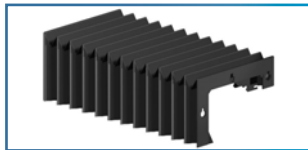

Trumpf No.	Order No.	Description
1307207, 1596086, 1873855	RBT130/50RX	X Axis Rail Bellow (Right/Front & Rear)



Trumpf No.	Order No.	Description
1302020, 1596087	RBT131/50RX	X Axis Rail Bellow (Left/Front & Middle)

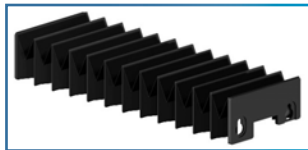

Trumpf No.	Order No.	Description
1302386	RBT133/50RU	U Axis Rail Bellow (Front & Rear)

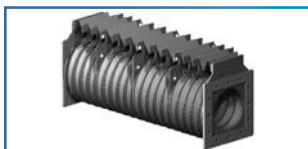

Trumpf No.	Order No.	Description
1271514	RBT134/50UXBP	U & X Axis Round Beam Path Bellow



Trumpf No.	Order No.	Description
1302018, 1596088	RBT135/50RX	X Axis Rail Bellow (Left/Rear)



Trumpf No.	Order No.	Description
1226193	RBT137/50RY	Y Axis Rail Bellow (Right)



Trumpf No.	Order No.	Description
1353514	RBT139/50RBY	Y Axis Round Beam/Rail Combo Bellow (Left)

TRUMPF® machine models are for reference only, please check your machine manual for the actual part number needed. Our technical drawings can be found at www.rellaser.com. Please contact us if you do not find the item you need.



For TruLaser 3040 (L32)

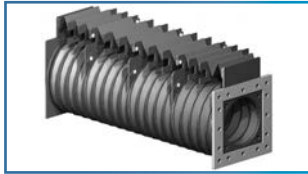

Trumpf No.	Order No.	Description
1354090	RBT321/3040/L32BX	X Axis Beam Bellow (Front)

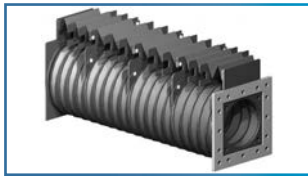

Trumpf No.	Order No.	Description
1354091	RBT320/3040/L32BPX	X Axis Beam Path Bellow (Rear)



Trumpf No.	Order No.	Description
1354092	RBT323/3040/L32BY	Y Axis Beam Bellow (Right)



Trumpf No.	Order No.	Description
1354093	RBT322/3040/L32BPY	Y Axis Beam Path Bellow (Left)



Trumpf No.	Order No.	Description
1802795	RBT343/3040L32RBY	Y-Axis Beam/Rail Combo Bellow

TRUMPF® machine models are for reference only, please check your machine manual for the actual part number needed. Our technical drawings can be found at www.rellaser.com. Please contact us if you do not find the item you need.



For L4030 & TruLaser 3040

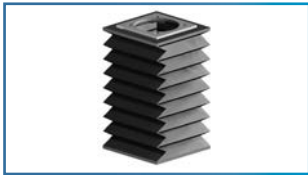

Trumpf No.	Order No.	Description
0910354, 124395, 0124395, 2342414	RBT102/30BPZ	Z Axis Beam Path Bellow

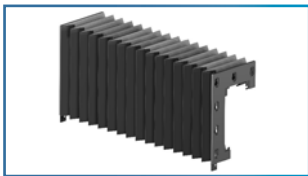

Trumpf No.	Order No.	Description
0921870, '1883139	RBT107/40RX	X Axis Rail Bellow (each)

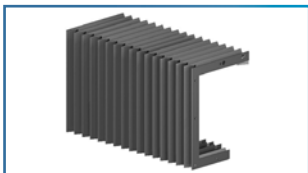

Trumpf No.	Order No.	Description
144949	RBT108/40RY	Y Axis Rail Bellow (each)



Trumpf No.	Order No.	Description
939017, 0342573, 0939017, 2335182	RBT110/40BPX *	X Axis Beam Path Bellow (Rear)



Trumpf No.	Order No.	Description
0938000, 2335183	RBT111/40BPY	Y Axis Beam Path Bellow (Left)



Trumpf No.	Order No.	Description
0920718, 0975011, 0976624, 2335292	RBT112/40BX *	X Axis Beam Bellow (Front)

*If your laser has the long beam clipper (typically found on machines built prior to 2000) it will need to be changed to the newer shorter version before using this replacement bellow.

TRUMPF® machine models are for reference only, please check your machine manual for the actual part number needed. Our technical drawings can be found at www.rellaser.com. Please contact us if you do not find the item you need.



For L4030 & TruLaser 3040

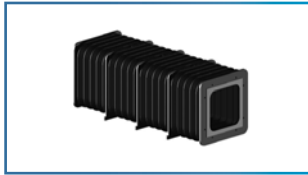

Trumpf No.	Order No.	Description
0920719, 2335130	RBT113/40BY	Y Axis Beam Bellow (Right)



Trumpf No.	Order No.	Description
1504308, 1559318	RBT280/34RBPY	Y Axis Beam Path/Rail Combo Round Bellow (Left)



Trumpf No.	Order No.	Description
1561305	RBT326/3040NBX	X-Axis Beam Bellows (front)

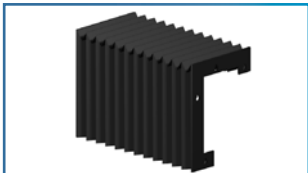

Trumpf No.	Order No.	Description
1570975, 1865321	RBT340/4030L32RRX	X Axis Rail Bellow (Right)



Trumpf No.	Order No.	Description
1559392	RBT342/4030L32RBY	Y Axis Beam/Rail Combo Round Bellow (Right)

TRUMPF® machine models are for reference only, please check your machine manual for the actual part number needed. Our technical drawings can be found at www.rellaser.com. Please contact us if you do not find the item you need.



For L6030



Trumpf No.	Order No.	Description
0910354, 124395, 0124395, 2342414	RBT102/30BPZ	Z Axis Beam Path Bellow

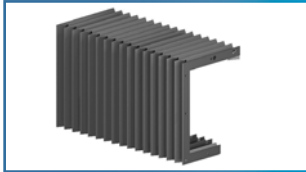

Trumpf No.	Order No.	Description
0144949	RBT108/40RY	Y Axis Rail Bellow

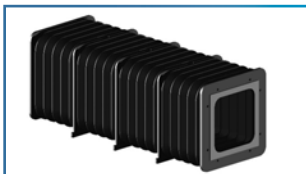

Trumpf No.	Order No.	Description
0938000	RBT111/40BPY	Y Axis Beam Path Bellow (Left)

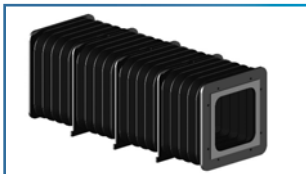

Trumpf No.	Order No.	Description
0920719	RBT113/40BY	Y Axis Beam Bellow (Right)



Trumpf No.	Order No.	Description
0921871	RBT140/60RX	X Axis Rail Bellow



Trumpf No.	Order No.	Description
0920730	RBT141/60BX	X Axis Beam Bellow (Front)



Trumpf No.	Order No.	Description
0937999	RBT142/60BPX	X Axis Beam Path Bellow (Rear)

TRUMPF® machine models are for reference only, please check your machine manual for the actual part number needed. Our technical drawings can be found at www.rellaser.com. Please contact us if you do not find the item you need.



For L5030 (L16)

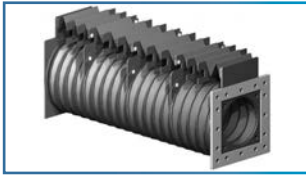

Trumpf No.	Order No.	Description
1323286	RBT350/5030L16UXBP	U & X Axis Beam Path Bellow



Trumpf No.	Order No.	Description
1595345	RBT365/5030F-Z	Z Axis Bellow

For L5040

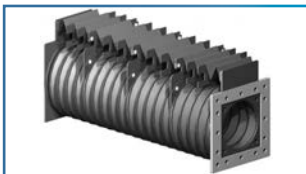

Trumpf No.	Order No.	Description
1306471, 1370070	RBT210/45BPU	U Axis Beam Path Bellow

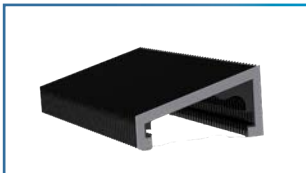

Trumpf No.	Order No.	Description
1946658	RBT360/5040RY	Y Axis Rail Bellow

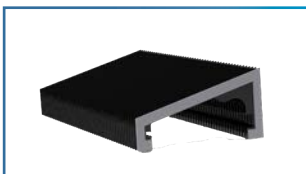

Trumpf No.	Order No.	Description
1485231	RBT380/5040L18RY	Y Axis Rail Bellow

TRUMPF® machine models are for reference only, please check your machine manual for the actual part number needed. Our technical drawings can be found at www.rellaser.com. Please contact us if you do not find the item you need.



For L4050 & TruLaser 5040

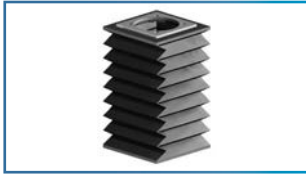

Trumpf No.	Order No.	Description
0910354, 124395, 0124395, 2342414	RBT102/30BPZ	Z Axis Beam Path Bellow

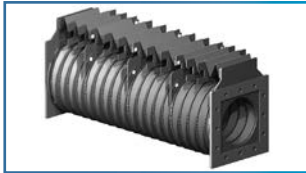

Trumpf No.	Order No.	Description
1306474	RBT154/2030BPX	X Axis Beam Path Bellow



Trumpf No.	Order No.	Description
1222110	RBT200/45RBPY	Y Axis Beam Path/Rail Combo Bellow



Trumpf No.	Order No.	Description
1222111	RBT201/45RY	Y Axis Rail Bellow



Trumpf No.	Order No.	Description
1222576	RBT202L/45BPX	X Axis Beam Path Bellow

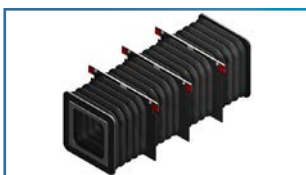

Trumpf No.	Order No.	Description
1222575, 2334587	RBT203L/45BPU	U Axis Beam Path Bellow

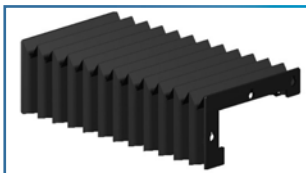

Trumpf No.	Order No.	Description
1222573	RBT204/45RXR	X Axis Rail Bellow (Right Front & Rear)

TRUMPF® machine models are for reference only, please check your machine manual for the actual part number needed. Our technical drawings can be found at www.rellaser.com. Please contact us if you do not find the item you need.

For L4050 & TruLaser 5040

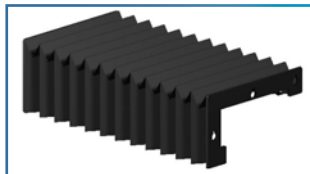

Trumpf No.	Order No.	Description
1222529, 1893488	RBT205/45RXLF *	X Axis Rail Bellow (Left Middle & Front)

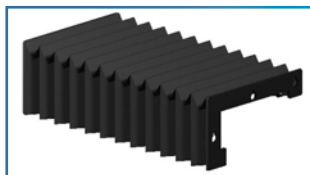

Trumpf No.	Order No.	Description
1222571, 1893487	RBT206/45RXLB *	X Axis Rail Bellow (Left/Rear)



Trumpf No.	Order No.	Description
1222528	RBT207/45RU	U Axis Rail Bellow



Trumpf No.	Order No.	Description
1353516	RBT208/45RBPY	Y Axis Beam Path/Rail Combo Bellow

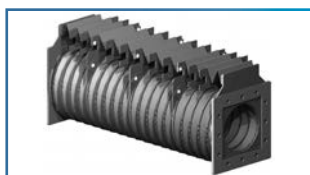

Trumpf No.	Order No.	Description
1306471, 1370070	RBT210/45BPU	U Axis Beam Path Bellow

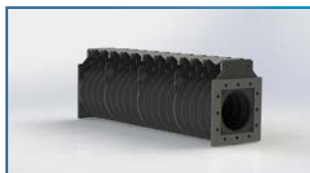

Trumpf No.	Order No.	Description
1306470	RBT470/45BXL	X-Axis Left Beam Path Disk Bellow

*Please confirm the open & closed lengths of your machine, as some Trumpf manuals call out the bellows incorrectly.

TRUMPF® machine models are for reference only, please check your machine manual for the actual part number needed. Our technical drawings can be found at www.rellaser.com. Please contact us if you do not find the item you need.



For L6050

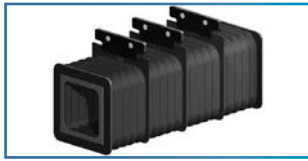

Trumpf No.	Order No.	Description
1262706, 2335000	RBT152/25BY	Y Axis Beam Bellow

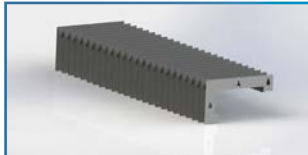

Trumpf No.	Order No.	Description
1251452, 1987171	RBT220/6050RXR	X Axis Right Rail Bellow

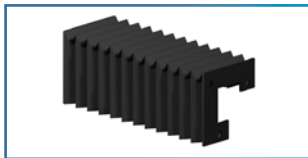

Trumpf No.	Order No.	Description
1251454, 1987172	RBT221/6050XLB	X Axis Left Back Rail Bellow



Trumpf No.	Order No.	Description
1251453, 1987173	RBT222/6050RXLf	X Axis Left Front Rail Bellow

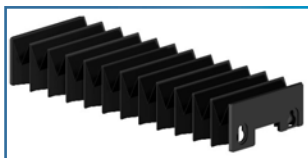

Trumpf No.	Order No.	Description
1251455, 1987174	RBT223/6050RU	U Axis Rail Bellow

For 2503



Trumpf No.	Order No.	Description
128165	RBT150/25RX	X Axis Rail Bellow

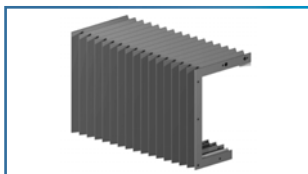

Trumpf No.	Order No.	Description
105757	RBT151/25RY	Y Axis Rail Bellow

TRUMPF® machine models are for reference only, please check your machine manual for the actual part number needed. Our technical drawings can be found at www.rellaser.com. Please contact us if you do not find the item you need.



For L2530 & TruLaser 2525

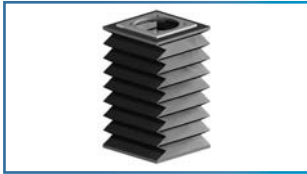

Trumpf No.	Order No.	Description
0910354, 124395, 0124395, 2342414	RBT102/30BPZ	Z Axis Beam Path Bellow

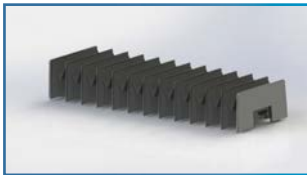

Trumpf No.	Order No.	Description
0135401, 135402	RBT160/25RX	X Axis Rail Bellow (Front)

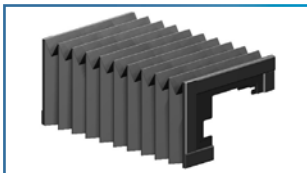

Trumpf No.	Order No.	Description
0135401	RBT161/25RX	X Axis Rail Bellow (Rear)

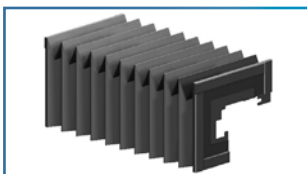

Trumpf No.	Order No.	Description
0135399	RBT162/25RY	Y Axis Rail Bellow (Right & Left)

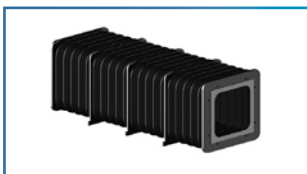

Trumpf No.	Order No.	Description
0925803, 2335181	RBT163/25BX	X Axis Beam Bellow (Right)

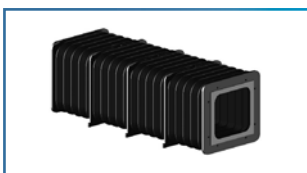

Trumpf No.	Order No.	Description
0939013	RBT164/25BPX	X Axis Beam Path Bellow (Left)

TRUMPF® machine models are for reference only, please check your machine manual for the actual part number needed. Our technical drawings can be found at www.rellaser.com. Please contact us if you do not find the item you need.



For L2530 & TruLaser 2525

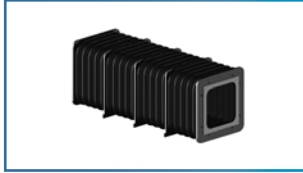

Trumpf No.	Order No.	Description
0354501, 0939014	RBT165/25BPY	Y Axis Beam Path Bellow (Rear)

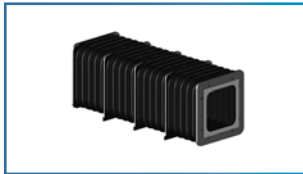

Trumpf No.	Order No.	Description
0925802	RBT166/25BY	Y Beam Bellow (Front)

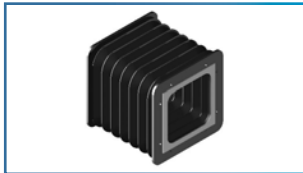

Trumpf No.	Order No.	Description
0939012	RBT167/25BPY	Y Axis Beam Path Bellow (Middle)

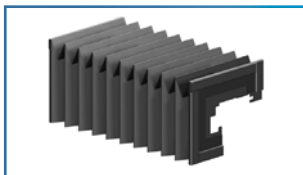

Trumpf No.	Order No.	Description
0980133	RBT168/25RY	Y Axis Rail Bellow (Right & Left)

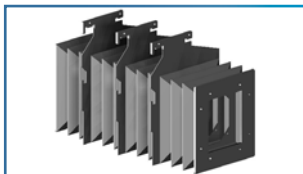

Trumpf No.	Order No.	Description
0352336, 2334809	RBT330/2525BPY	Y Axis Beam Path Bellow for the TruLaser 2525

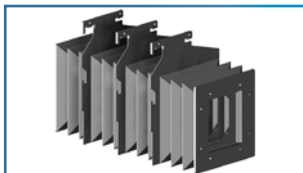

Trumpf No.	Order No.	Description
0352335, 2334585	RBT331/2525BY	Y Axis Beam Bellow for the TruLaser 2525

TRUMPF® machine models are for reference only, please check your machine manual for the actual part number needed. Our technical drawings can be found at www.rellaser.com. Please contact us if you do not find the item you need.



For L2030 & TruLaser 2030



Trumpf No.	Order No.	Description
1306474	RBT154/2030BPX	X Axis Beam Path Bellow



Trumpf No.	Order No.	Description
1438662	RBT156/25BPY	Y Axis Beam Path Bellow



Trumpf No.	Order No.	Description
1264021	RBT157/25RX	X Axis Rail Bellow



Trumpf No.	Order No.	Description
1830943	RBT410/2030RX	X Axis Rail Bellow

For L2510



Trumpf No.	Order No.	Description
1262706, 2335000	RBT152/25BY	Y Axis Beam Bellow



Trumpf No.	Order No.	Description
1262704, 2334588	RBT153/25BPY	Y Axis Beam Path Bellow

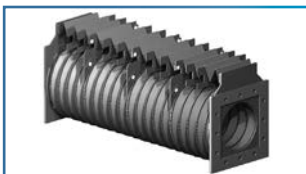

Trumpf No.	Order No.	Description
1306474	RBT154/2030BPX	X Axis Beam Path Bellow



Trumpf No.	Order No.	Description
1264021	RBT157/25RX	X Axis Rail Bellow

TRUMPF® machine models are for reference only, please check your machine manual for the actual part number needed. Our technical drawings can be found at www.rellaser.com. Please contact us if you do not find the item you need.



For L1005 (3 Meter Bed)



Trumpf No.	Order No.	Description
0139851	RBT180/10BPX3M	X Axis Beam Path Bellow (Right)



Trumpf No.	Order No.	Description
0139850	RBT181/10BX3M	X Axis Beam Bellow (Left)



Trumpf No.	Order No.	Description
0139852	RBT182/10BBY	Y Axis Beam & Beam Path Bellow (Front & Rear)

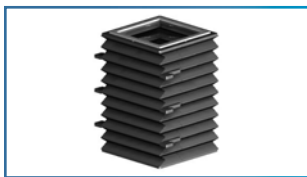

Trumpf No.	Order No.	Description
0140805	RBT183/10BPZ	Z Axis Beam Path Bellow



Trumpf No.	Order No.	Description
0139853	RBT184/10URX3M	U Axis Rail Bellow (Left & Right)

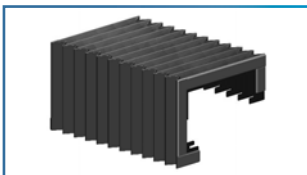

Trumpf No.	Order No.	Description
0139854	RBT185/10RX3M	X Axis Rail Bellow (Left)

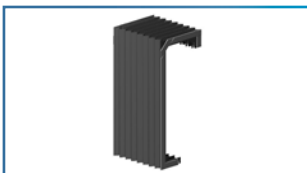

Trumpf No.	Order No.	Description
0140160	RBT187/10RY	Y Axis Rail Bellow (Front & Rear)

TRUMPF® machine models are for reference only, please check your machine manual for the actual part number needed. Our technical drawings can be found at www.rellaser.com. Please contact us if you do not find the item you need.



For 1030

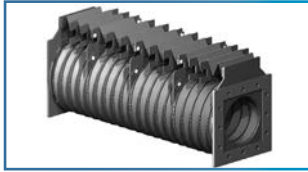

Trumpf No.	Order No.	Description
1306474	RBT154/2030BPX	X Axis Beam Path Bellow

For L7040



Trumpf No.	Order No.	Description
1761999	RBT300/74RX	X-Axis Rail Bellow



Trumpf No.	Order No.	Description
1761995	RBT370/7040RXLL	X-Axis Lower Left Rail Bellow

For L8030 (L60)



Trumpf No.	Order No.	Description
1761999	RBT300/74RX	X-Axis Rail Bellow



Trumpf No.	Order No.	Description
1761994	RBT400/8030L60RYUR	Y-Axis Rail Bellow

For Nozzle Changer



Trumpf No.	Order No.	Description
1586465	RBT465/NZCHG	Rail bellows for lasers with nozzle changer

TRUMPF® machine models are for reference only, please check your machine manual for the actual part number needed. Our technical drawings can be found at www.rellaser.com. Please contact us if you do not find the item you need.



For Fiber Lasers



Trumpf No.	Order No.	Description
1595381, 2280265	RBT215/5030FIBER-RY	Y-Axis Rail Bellow, 5030 L41 Fiber



Trumpf No.	Order No.	Description
1722672, 1865270	RBT216/5030FIBER-LXR	X-Axis Rail Bellow (Left), 5030 Fiber



Trumpf No.	Order No.	Description
2072783	RBT415/3060FIBER-RY	Y-Axis Rail Bellow, 3060 Fiber



Trumpf No.	Order No.	Description
2072781	RBT170/30RY	Y-Axis Rail Bellow, 5030 (L76) Fiber, 3030 (L81) Fiber



Trumpf No.	Order No.	Description
1931838	RBT213/5040F-RY	Y-Axis Rail Bellow, 5040 Fiber



Trumpf No.	Order No.	Description
1946711	RBT214/RZB	Z-Axis Bottom Rail Bellow



Trumpf No.	Order No.	Description
2446554, 2918570, 2446507, 2918638	RBT240/50RY	Y-Axis Rail Bellow, 3030 & 5030 Fiber



Trumpf No.	Order No.	Description
2446508, 2918662	RBT241/3060F-RY	Y-Axis Rail Bellows for 3060 Fiber

TRUMPF® machine models are for reference only, please check your machine manual for the actual part number needed. Our technical drawings can be found at www.rellaser.com. Please contact us if you do not find the item you need.



Dust Collection Filters

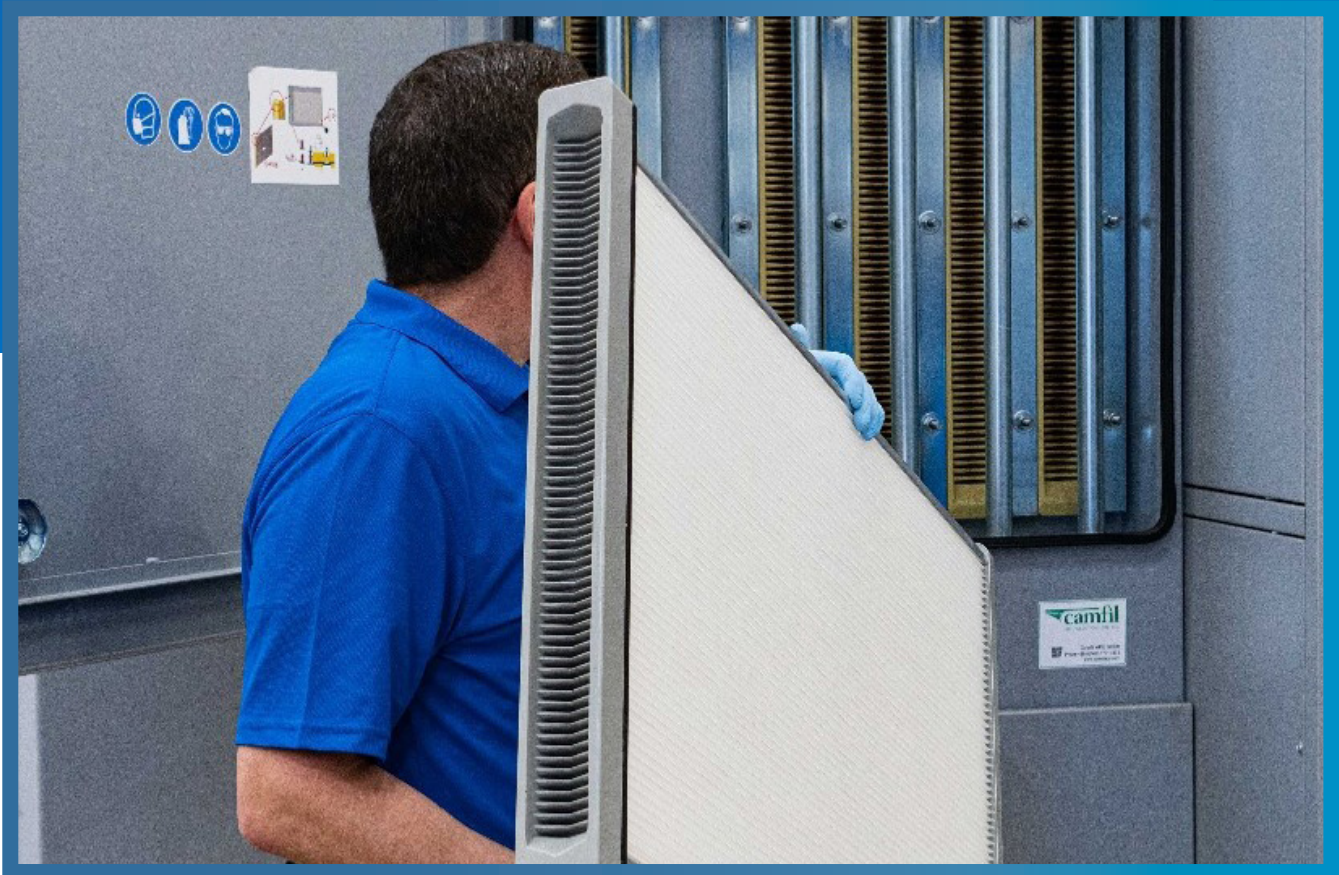

Richardson Electronics is one of the largest aftermarket suppliers of highest quality German-made filters. High quality filtration is directly related to the health and safety of your technicians and staff, it is important that they be replaced as needed to ensure maximum efficiency and a healthy work environment.

Key features and benefits of Richardson Electronics Dust Collection Filters:

- Designed to fit the Handte®, Camfil®, and Keller® dust extractors, found on most Trumpf lasers as direct drop-in replacements
- Made with laser-grade filter media from spun polyester with a thermal bonded PTFE membrane
- Flat panel filters are constructed using tip-to-tip gluing, providing longer life
- Certified to HEPA filtration standards of H13 - H14, capable of removing up to 99.995% of finest laser dust
- Meets OEM quality standards
- Made in Europe by experts with more than 30 years of experience in filtration technology
- Competitively priced

Richardson Electronics, Ltd. | rellaser.com | laser@rell.com | Find our Local Sales Offices at rell.com/contact-us

All product and company names are trademarks™ or registered® trademarks of their respective holders. Use of the trademarks is solely for identification purposes, and does not imply any affiliation with or endorsement by the trademark holders.



Dust Collection Filters

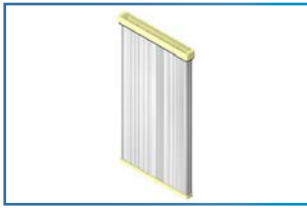

Trumpf No.	Order No.	Description
0344014, 0345064, 0346113, 0346118, 0359584, 0359585, 0359586, 1533834, 2625632, 2306137, 1457341	RFT064/10	For Handte systems MF-L-30/6/1, MF-L-40/8/1 & MF-L-50/10/1, includes gasket

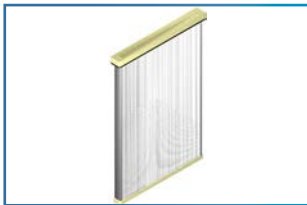

Trumpf No.	Order No.	Description
0146122, 0342682, 0342812, 593869	RFT122/10A	For KellerVario T1.5 (L2530, L3030, L4030, L6030 & TLC1005), includes gasket

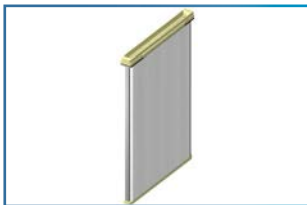

Trumpf No.	Order No.	Description
0384514, 0386275	RFT275/600	For Handte MF-L-17/8/1-L20/20 (L1030), includes gasket

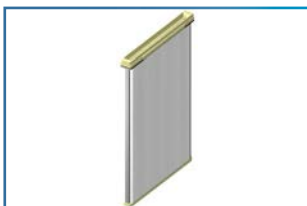

Trumpf No.	Order No.	Description
1746376, MF-L1000	RFT376/1000	Dust filter suitable for MF-L1000



Trumpf No.	Order No.	Description
2081624, 2249201, 2308133, 2337521, 2347048, 2485946, 2626348	RFT521/10	For Camfil Entry 1500/2000, includes gasket



Trumpf No.	Order No.	Description
2050706, 2061618, 2260691	RFT691/1100	For Camfil systems MF-8.4, MF-8.5 & MF-8.6, includes gasket

Did you know that cleaning and replacing filters as needed ensures your dust collection system is operating at peak efficiency and thereby keeping your staff safe from the harmful dust generated during the cutting process? **Have you replaced your filters.**



Dust Collection Filters

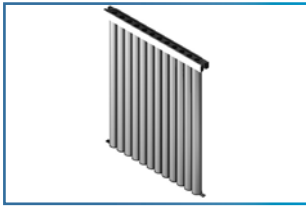

Trumpf No.	Order No.	Description
0380757, 1577250, 1740803, 1938301, 2042139, 59113119, 0383837, 1932923	RFT757/10	For Handte systems MF-L-2000, MF-L-2500 & MF-L-3000, includes gasket



Trumpf No.	Order No.	Description
0139809, 0148491	RFT809/600	For Handte systems MF-B-17/8/1, includes gasket



Trumpf No.	Order No.	Description
0340484	RFT484/125	For Keller Vario T2.5 & T3.0 systems, includes gasket



Trumpf No.	Order No.	Description
0141759	RFT759/10	For Keller Vario T1.0 systems (L2530), includes gasket

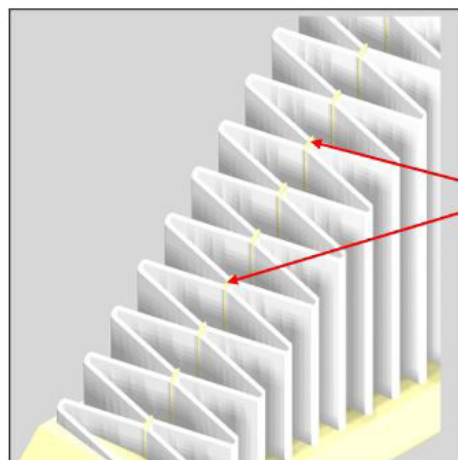

Flat panel filters feature tip-to-tip Construction, for maximum strength, providing longer life



Donaldson Air Filters



Trumpf No.	Order No.	Description
0123674, 0377006	1C125116	Ultrain FF 03/10 .01µm Silicon Free Fine Filter Element
0147240	1C125432	Ultrain MFP05/20 Silicon Free Air Filter
0123675, 0377005	1C125716	Ultrain SMF 03/10 .01µm Silicon Free Sub-Micro Filter Element
0147241	1C125732	Ultrain SMFP05/20 Silicon Free Air Filter
0123676, 0377004	1C125824	Ultrain AK 04/20 Silicon Free Activated Carbon Absorption
0147239	1C170032-25	Ultrain PEP 05/20 Silicon Free Air Filter



Chiller System



The Chiller Systems on Trumpf lasers require annual changes to the water and chemicals to ensure proper cooling of the laser systems. Our Copper (Cu) and Aluminum (Al) Water Treatment Kits are equivalent to the OEM Easy Kits. Each kit contains the exact amount of biocide and either copper or aluminum inhibitor for each size of tank.

Proper precautions should always be taken when handling these, or any other, chemicals. The use of gloves and safety glasses (included with each kit) is highly recommended.



Water Treatment Kits

NEW in Europe

Water treatment kits coming soon – Autumn 2025

Copper Kits

Trumpf No.	Order No. (North America)	Order No. Europe (incl. all EMEA)	Order No. (Latin America & Asia)	Tank Size, Liters	Description
1652981, 1652991, 1652992	RWK991/EZCU1NA	RWK201/EZCU1EU		5-14	Easy-Kit Copper 1
1652995, 1653088, 1653089	RWK088/EZCU2NA	RWK202/EZCU2EU		15-49	Easy-Kit Copper 2
1653112, 1653113, 1653114	RWK113/EZCU3NA	RWK203/EZCU3EU	RWK113-P/EZCU3NA	50-119	Easy-Kit Copper 3
1653107, 1653108, 1653109	RWK108/EZCU4NA	RWK210/EZCU4EU	RWK108-P/EZCU4NA	120-359	Easy-Kit Copper 4
1653124, 1653125, 1653132	RWK124/EZCU5NA	RWK220/EZCU5EU		360-999	Easy-Kit Copper 5

Aluminum Kits

Trumpf No.	Order No. (North America)	Order No. Europe (incl. all EMEA)	Order No. (Latin America & Asia)	Tank Size, Liters	Description
1652091, 1652606, 1652623	RWK623/EZAL1NA	RWK300/EZAL1EU	RWK623-P/EZAL1NA	30-79	Easy-Kit Aluminum 1
1652607, 1652630, 1652631	RWK631/EZAL2NA	RWK310/EZAL2EU		80-199	Easy-Kit Aluminum 2
1652605, 1652608, 1652609	RWK608/EZAL3NA	RWK320/EZAL3EU	RWK608-P/EZAL3NA	200-599	Easy-Kit Aluminum 3
1652964, 1652965, 1652968	RWK965/EZAL4NA	RWK330/EZAL4EU		600-1199	Easy-Kit Aluminum 4



Water Filters, Filter Material, & Conductivity Meter

The vents on the doors of the chiller cabinet gather a lot of dust and dirt, which can prevent proper ventilation of the cabinet. Regularly replacing the filter material makes certain the components inside the cabinet stay clean with the required airflow. The filter material has a MERV6 rating. Rolls are shipped in over-size cartons and are not available in all countries.



Chiller Filter Material

Trumpf No.	Order No.	Description
0343298	RFT100/1X20	Sold in rolls - 1/2" x 39.4" x 65.6' (13mm x 1M x 20M)
	RFT101/25X65	Sold in rolls - 1/2" x 25" x 65' (13mm x 0.64M x 20M)

When doing the periodic water change, it is important to also replace the water filters.

Use the genuine Chisso filters that have the specific filtration required for Trumpf lasers.



Filters

Trumpf No.	Order No.	Description
0143106, 0146152	CP102480	Chisso 10 µm Water Filter, 10" (250mm)
1888631	RFT102/20-50UM	Chisso 50 µm Water Filter, 20" (508mm) (Used on newer fiber lasers)

Keeping the water clean is the #1 maintenance tip you should follow. You want to keep the purity of the water within the manufacturers recommended conductivity levels, measured in micro-Siemens (µS), to prevent corrosion of the valuable copper and aluminum components in your laser. Measuring the conductivity of your chiller water is quick and easy. Simply turn on the meter, insert the probe end into the water and view the reading on the LCD display. It's that simple! The lower the conductivity reading, the better your water quality is!



Conductivity Meter

Trumpf No.	Order No.	Description
	HI98311	Hanna Water Conductivity Meter



Other Manufacturers

Are you looking for laser parts and consumables for machines from other manufacturers? Look no further! Below you will find links to other laser products we supply.

[Contact Richardson Electronics](#) today for additional information, if you are unable to find the part you need, or [request a quote](#).



Laser Parts for Amada

Optics

rellaser.com/laser-optics/amada



Laser Parts for Mazak

Optics

rellaser.com/laser-optics/mazak



Laser Parts for BLM/Adige

Dust Collection Filters

rellaser.com/dust-collection-filters/blm-adige



Laser Parts for Mitsubishi

Optics

rellaser.com/laser-optics/mitsubishi

Laser Consumables

rellaser.com/laser-nozzles-and-accessories/blm-adige



Laser Parts for Precitec®

Laser Consumables

rellaser.com/laser-nozzles-and-accessories/precitec



Laser Parts for Bystronic®

Bellows

rellaser.com/laser-bellows/bystronic

Optics and Cleaning Supplies

rellaser.com/laser-optics/precitec

Dust Collection Filters

rellaser.com/dust-collection-filters/bystronic



Laser Parts for Prima

Bellows

rellaser.com/laser-bellows/prima

Filters - Air

rellaser.com/other-laser-consumables/bystronic

Laser Consumables

rellaser.com/laser-nozzles-and-accessories/bystronic

Optics and Cleaning Supplies

rellaser.com/laser-optics/bystronic

RF/Switch Tube and Accessories

rellaser.com/power-grid-tubes/bystronic



POWER & MICROWAVE
TECHNOLOGIES

Find our Local Sales Offices at rell.com/contact-us

rellaser.com | laser@rell.com